

**digital audio**

weiss engineering ltd.  
Florastrasse 42, 8610 Uster, Switzerland

+41 | 940 20 06 +41 | 940 22 14

<http://www.weiss.ch> / <http://www.weiss-highend.com>

**weiss**



# GAMBIT

# ADC2

# OPERATING MANUAL

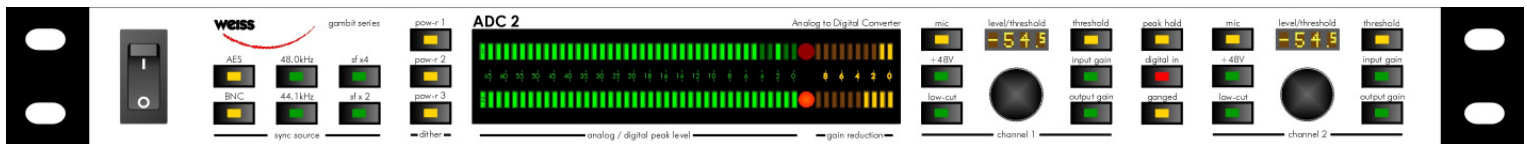

Software Version: 3.0

# INTRODUCTION

## Congratulations on purchasing the Weiss Gambit Series ADC2 A/D Converter !

The ADC2 is a two channel A/D converter designed for most demanding audio applications. It uses state of the art A/D chips in Weiss Engineering's proven "correlation technique" configuration, which lowers converter imperfections and improves the SNR ratio.

For best noise rejection, the analogue input signal is kept balanced from the input connectors up to the converter chips. A high quality microphone preamp is available as a standard feature.

Additionally, there is a built-in digital two-segment compressor / limiter for optimal leveling, employing adaptive release timing, look-ahead circuitry and sidechain-oversampling for mastering-quality dynamics processing.

Large bar graphs, a well thought-out push button array and uncluttered rotary knobs optimize handling ergonomics.

### Summary of ADC2 features:

#### Inputs

- Two balanced LINE and two MIC inputs on separate XLR connectors.
- MIC input with switchable phantom power.
- Input sensitivity is settable in each channel independently (or ganged) with two rotary encoders.
- Line Input sensitivity: -16dBu to +26 dBu.
- Mic Input sensitivity: -54dBu to +6dBu.
- Separate AES/EBU input on XLR for synchronization and/or audio input to the DSP, which allows for use of the ADC2 for redithering and limiting of digital signals.

#### Synchronization

- Internal sync selectable 44.1kHz, 48kHz, 88.2kHz, 96kHz, 176.4kHz, 192kHz.
- External sync from Wordsync Input (BNC) or from AES/EBU input.
- Wordsync output on a BNC connector.

#### Metering

- One input / output level bargraph per channel with short peak hold
- One gain reduction bargraph per channel.
- Two over LEDs
- Two numerical displays for peak hold and level settings.
- Reference for level setting can be altered

#### Outputs

- AES/EBU on XLR in one or two wire format
- S/PDIF on RCA
- Firewire (to be implemented).

#### DSP

- POW-R dithering to 16 bits, settable to three different algorithms according to the POW-R standard.
- SNR enhancement.
- Level bar graph meter.
- Two segment compressor / peak limiter
- Double-precision 40bit floating-point processing

# OPERATION

## ADC2 Block Diagram

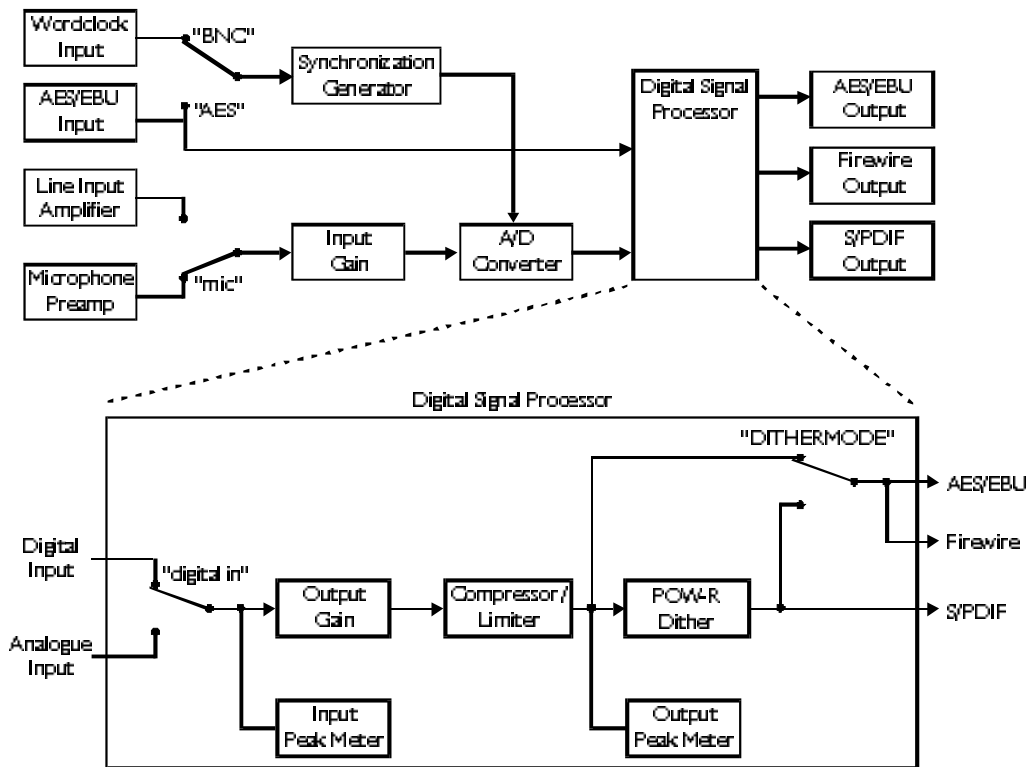

Fig. 1 ADC2 Block Diagram Schematic

## Input Control Panel

This section describes how to use the input control panel (see Fig. 2).



Fig. 2 ADC2 Input Control Panel

## Ganged

For stereo use, press the “ganged” key. This locks together channel 1 and channel 2 gain and threshold controls. Additionally, if “ganged” is active,

active, the compressor / limiter links<sup>1</sup> the sidechains of the two channels. Typical applications for “ganged” mode are

- stereo (left/right) recordings with two microphones
- stereo insert limiting (during mixdown or mastering).

If “ganged” is not active, channel 1 and channel 2 settings are independent and the compressor / limiter works unlinked. Thus the ADC2 can also be used in a studio recording / mixing environment as dual channel outboard compressor / limiter.

A 3.3ms delay is used by the limiter for preview.

<sup>1</sup> “sidechain linking ” means that the same gain reduction is applied to both channels to avoid corrupting the stereo balance.

## Digital In

Pressing the “*digital in*” key activates the digital AES/EBU XLR input, the key lights red if active. As soon as a valid signal is present, the sampling rate is displayed with the sampling rate keys (see Fig. 6).

If the digital input stage does not lock to any signal, none of the sampling rate keys are lit.

If the “*digital in*” key is not lit, the analogue inputs are selected. To activate the microphone input for either channel, press the appropriate “*mic*” key (if “*ganged*” is active, pressing one “*mic*” key will select microphone inputs for both channels). Press “+48V” if phantom power is needed.

It is usually advisable to use “*low-cut*” when recording with microphones. If “*low-cut*” is lit, low frequency content (traffic rumble, building tremors, air-condition hum and other low-frequency air movement like doors opening or closing near the microphone etc.) is filtered out.

## Peak Hold

If “*peak hold*” is lit, the numeric display shows the peak hold value (in dBFS) which is selected by the gain key: “*input gain*” selects the input peak hold, “*output gain*” selects the output peak hold (“*threshold*” also selects output peak hold). See Fig. 1 for positioning of input and output peak hold in the processing chain.

If input peak hold is selected, values equal to or above 0.0dBFS are indicated by “>=0”. The output peak hold however can measure values above 0.0dBFS because of the internal floating-point data format used in the digital signal processor. This is very useful to set the output gain.

**To clear the peak hold value, double-click the “*peak hold*” key!**

Double-click resets both input and output peak hold.

## Input Gain

If “*input gain*” is lit, the rotary knobs control the analogue input sensitivity. This is adjusted in 1dB steps via a relais controlled attenuator. The selected value is shown in the numeric display.

The level bargraph is switched between input and output in the same manner as the peak hold. Thus, if the “*input gain*” key is lit, the bargraph displays the input peak meter. If the “*output gain*” key is lit, the bargraph displays the output peak meter (settings can be different if “*ganged*” is not lit).

Refer to Fig. 1 on p. 3 for positioning of input and output peak meter in the processing chain.

**Note:** The reference for the input sensitivity display can be chosen by the user. For that purpose press and hold the “*ganged*” key and then switch the ADC2 on. After a few seconds release the ganged key. Wait for a few more seconds. Now you can select the reference with the righthand knob. This allows to set the reference to e.g. +4dBu. Factory setting is 0 dBu reference. When finished press the blinking “*peak hold*” key. The setting is retained in non-volatile memory.

## Output Gain

If “*output gain*” is lit, the rotary knobs control the digital output gain. This gain can be used for optimal gain adjustment and to drive the peak limiter (see below).

The gain ranges from  $-\infty$  (off) to +18.0 dB, the resolution is optimized for fine control around 0.0 dB while still allowing complete fade-out. A special algorithm is used for click-free gain transisions (no “*zipper*” noise).

**Threshold**

If “*threshold*” is lit, the rotary knobs control the threshold of the compressor section. The value is shown in the numeric display. If “*peak hold*” is active, the output peak value is displayed.

The ADC2 has a two-segment dynamics compressor. The threshold can only be adjusted for the compressor section, which has a fixed ratio of 2:1.

The limiter has a fixed ratio of ∞:1 with a fixed threshold of 0.0 dBFS.

**Because the signal before the output gain never exceeds 0.0dBFS, the limiter is inactive if the output gain is 0.0dB.**

If the threshold is set to 0.0 and the output gain is below 0.0 the dynamics section is inactive. This setup is shown in the input vs. output graph in Fig. 3.

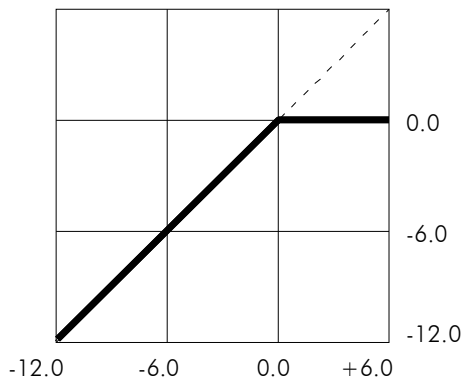

Fig. 3 Compressor with 0.0dB Threshold

To activate the limiter, set the output gain to a positive value. The boost will drive the signal into the limiter. The gain reduction applied by the limiter is visible on the yellow bargraphs.

To soften the transmission from linear to limiter segment, the compressor can be activated by adjusting the threshold parameter. Fig. 4 shows a setting with a threshold of -3 dBFS, Fig. 5 shows -6 dBFS. The range of possible threshold values is listed on p. 13.

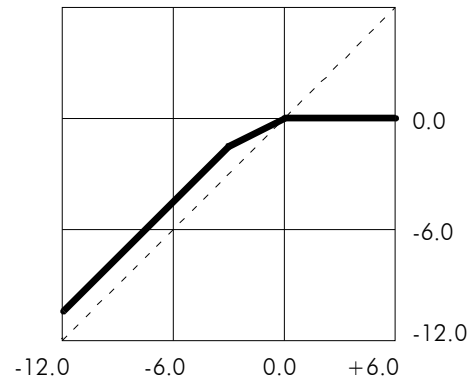
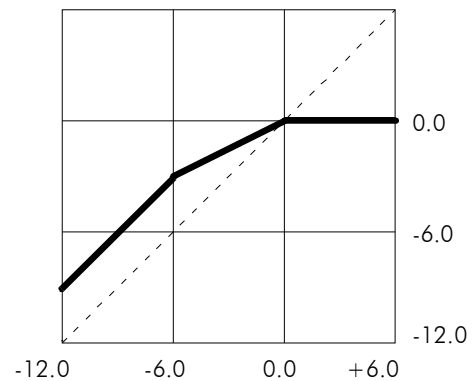

Fig. 4 Compressor with -3.0dB Threshold

Fig. 5 Compressor with -6.0dB Threshold



The overall gain reduction applied by the compressor / limiter is shown in the yellow bargraph.

Note that the compressor uses auto gain make-up: depending on the threshold, a gain is added after the compressor to ensure that 0.0 dBFS input results in 0.0 dBFS output (graphically speaking, auto gain make-up “fixes” the transfer curve at the (0.0, 0.0) point).

## Sync and Dither Control Panel

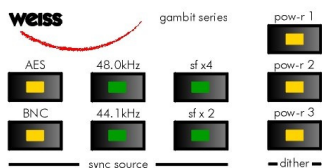

Fig. 6 ADC2 Sync and Dither Control Panel

### Output Frequency

If the analogue inputs are selected (“digital in” is not lit), the A/D sampling frequency can be set in the sync source block:

Sampling Frequency	44.1 / 48 kHz key	fs x 2 / fs x 4 key
44.1 kHz	44.1 kHz	none
48.0 kHz	48 kHz	none
88.2 kHz	44.1 kHz	sf x 2
96.0 kHz	48 kHz	sf x 2
176.4 kHz	44.1 kHz	sf x 4
192.0 kHz	48 kHz	sf x 4

Table 1 Samplig Frequency Selection

If “digital in” is lit, the sampling frequency keys display the sampling frequency of the AES/EBU input signal in the same fashion as is shown in Table 1.

### Sync Source

As can be seen in Fig. 1, the ADC2 can be synchronized externally by other digital devices. It has two external sync inputs. External sync is only available for analogue inputs, ie “digital in” key is not lit.

If “AES” is lit, the AES/EBU signal at the “DI 1 / SYNC” input is used for synchronization. If “BNC” is lit, the wordclock signal connected to “WORDSYNC in” is used for synchronization. Both sync inputs have a loop-through output to synchronize other devices.

If none of these two keys are lit, the ADC2 uses internal sync.

### POW-r Dither

To requantize the input signal from 24bit to 16bit format, a special technique is used to avoid distortion, called dithering. Many dithering schemes are available today, both professional and home-brewed. The ADC2 uses the POW-r scheme, which is widely regarded as one of the best, if not the best<sup>2</sup>, and is used in a variety of digital equipment.

The POW-r scheme offers three different presets which can be selected with the dither keys “pow-r 1”, “pow-r 2” and “pow-r 3”. The choice should be based on listening tests and preference of the recording engineer.

**Dithering is in “auto black”<sup>3</sup> mode: if digital zero is detected at the ouput, dithering is switched off. This ensures that programme breaks are not filled with dither noise.**

“Auto black” mode is not available for analogue input signals!

Also note the effect of the “DITHER MODE” dip switch setting in Fig. 1 ADC2 Block Diagram Schematic. If the dip switch is in the down position, requantisation to 16 bit and dithering is only applied to the S/PDIF RCA output, whereas the AES/EBU XLR output still carries all 24bits. This mode is useful for live recording to a 24bit device with simultaneous backup to a 16bit device (like DAT or CD-R). If the dip switch is in the up position, all digital outputs are dithered to 16bits.

<sup>2</sup> For press reviews of POW-r visit [www.weiss.ch/whatpresssays.html](http://www.weiss.ch/whatpresssays.html)

<sup>3</sup> The term “black” comes from digital image formats, where black is represented by the value zero.

### Why dither?

If the 24bit digital signal is not dithered when recording to 16bit media (e.g. DAT, CD-R etc), it is truncated instead, which leads to quantization distortion (similar to clipping distortion). Fig. 7 shows a 24bit sine wave at  $-85\text{dBFS}$  truncated to 16bit.

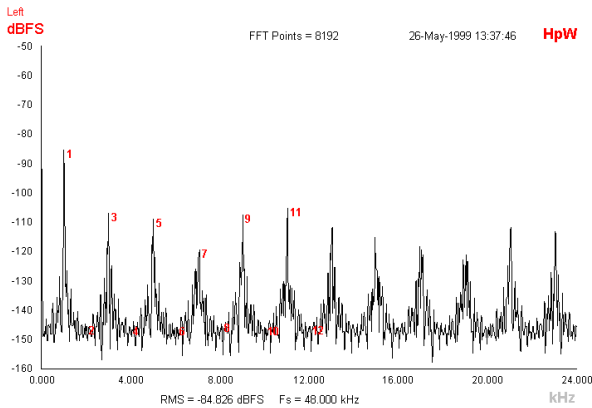

Fig. 7 1kHz Sine wave truncated to 16bit

If the same sine wave is dithered instead of quantized, the quantization distortion disappears and is replaced by wide band shaped noise, which is more pleasing to the human ear (Fig. 8).

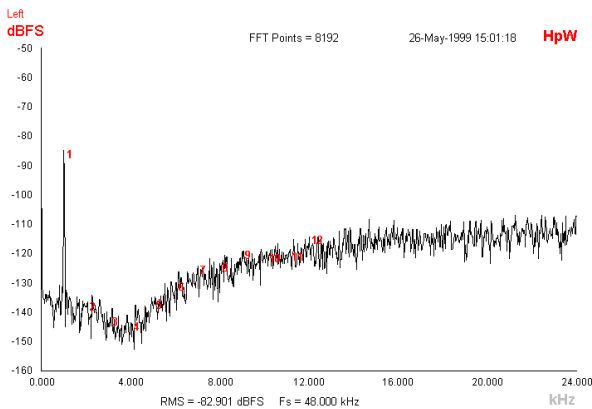

Fig. 8 1kHz sine wave dithered to 16bit

To view the frequency characteristics of the three POW-r algorithms, refer to POW-R Noise Spectrum on p. 14.

For more information on dithering in general, view the article “The Secrets of Dither” at [www.digido.com](http://www.digido.com).

For more POW-r information, please visit [www.weiss.ch/pow-r/pow-r.html](http://www.weiss.ch/pow-r/pow-r.html).

## Dip Switches



Fig. 9 Dip switches at the rear of the ADC2

DIP switch summary:

Switch	up	down
1	2 wire on XLR outputs	single wire on XLR outputs (both carry the same signal)
2	dither setting affects all outputs	dither setting affects only RCA output
3	WSYNC input on BNC <b>NOT</b> terminated	WSYNC input on BNC terminated
4	AES/EBU input <b>NOT</b> terminated	AES/EBU input terminated

## AES OUT 2 WIRE

If this switch is in the up position, the ADC2 outputs a two-wire signal. Refer to Table 2 and Table 3 to look up exact output configurations depending on this dip switch.

Sampling Freq.	DO1 (XLR 1)	DO2 (XLR 2)	DO3 (RCA)
44.1 kHz	44.1 kHz single wire	44.1 kHz single wire	44.1 kHz single wire
48 kHz	48 kHz single wire	48 kHz single wire	48 kHz single wire
88.2 kHz	44.1 kHz left channel	44.1 kHz right channel	<i>muted</i>
96 kHz	48 kHz left channel	48 kHz right channel	<i>muted</i>
176.4 kHz	88.2 kHz left channel	88.2 kHz right channel	<i>muted</i>
192 kHz	96 kHz left channel	96 kHz right channel	<i>muted</i>

Table 2 AES OUT 2 WIRE switch in up position

Sampling Freq.	DO1 (XLR 1)	DO2 (XLR 2)	DO3 (RCA)
44.1 kHz	44.1 kHz single wire	44.1 kHz single wire	44.1 kHz single wire
48 kHz	48 kHz single wire	48 kHz single wire	48 kHz single wire
88.2 kHz	88.2 kHz single wire	88.2 kHz single wire	88.2 kHz single wire
96 kHz	96 kHz single wire	96 kHz single wire	96 kHz single wire
176.4 kHz	176.4 kHz single wire	176.4 kHz single wire	176.4 kHz single wire
192 kHz	192 kHz single wire	192 kHz single wire	192 kHz single wire

Table 3 AES OUT 2 WIRE switch in down position

## DITHER MODE

This switch determines how dither is applied to XLR and RCA outputs. Refer to chapter POW-r Dither on p. 6 for further information.

## WSYNC TERM.

If the “*WORDSYNC in*” is not connected to another device (via a T-connector), this dip switch must be in the down position, in which case the signal is properly terminated.

If another unit is connected to the “*WORDSYNC in*”, this dip switch must be in the up position.

Regardless of input synchronization type, the “*WORDSYNC out*” always carries the word sync used by the ADC2.

## AES IN TERM.

If the loop-through output of the “*DI 1 / SYNC*” input is not connected to another device, this dip switch must be in the down position, in which case the line is properly terminated.

If another unit is connected, this dip switch must be in the up position.

## TECHNICAL DATA

### Analogue Line Inputs

2 channels, symmetrical, not earth free, on two XLR female connectors, pin 2 hot.  
Input Impedance > 5kOhm

### Analogue Microphone Inputs

2 channels, symmetrical, not earth free, on two XLR female connectors, pin 2 hot.  
Input Impedance > 5kOhm  
48V phantom power switchable

### AES/EBU Input

Input fs range:

- 44.1kHz
- 48.0kHz
- 88.2kHz
- 96.0kHz
- 176.4kHz
- 192.0kHz

All sampling frequencies must lie within  $\pm 100$ ppm of the nominal sampling frequency.

Maximum Input Wordlength: 24 Bits  
Connector: XLR female  
Impedance: 110 Ohm

### AES/EBU Output

Output fs range:

- 44.1kHz
- 48.0kHz
- 88.2kHz
- 96.0kHz
- 176.4kHz
- 192.0kHz

Maximum Output Wordlength: 24 Bits  
Channel Status Data: Professional format  
Connector: two times XLR male  
Impedance: 110 Ohm  
Format: single wire or double wire for fs higher than 48kHz  
(switch selectable)

## S/PDIF Output

Output fs range:	44.1kHz 48.0kHz 88.2kHz 96.0kHz 176.4kHz 192.0kHz
Maximum Output Wordlength:	24 Bits
Channel Status Data:	Professional format
Connector:	RCA female
Impedance:	75 Ohm

## WORDSYNC I/O

Input Connector:	BNC female
Input Impedance:	75 Ohm
Input Level:	TTL
Output Connector:	BNC female
Output Impedance:	4.7 Ohm
Output Level:	TTL

## Firewire

Not implemented in software versions 1.0 – 3.0

## Power

Mains Voltage:	110 / 220 Volts with voltage selector
Fuse rating:	0.63A slow blow
Power Consumption:	60VA max.

**Low cut frequency response:**

1st order highpass, 3dB point at 40Hz

**Frequency Response:**

@ fs = 44.1kHz: 20Hz ... > 20kHz +- 0.3dB

@ fs = 48.0kHz: 20Hz ... > 20kHz +- 0.3dB

@ fs = 88.2kHz: 20Hz ... > 30kHz +- 0.3dB

@ fs = 96.0kHz: 20Hz ... > 30kHz +- 0.3dB

@ fs = 176.4kHz: 20Hz ... > 40kHz +- 0.3dB

@ fs = 192.0kHz: 20Hz ... > 40kHz +- 0.3dB

**THD+N @ 1kHz:**

less than -103 dBFS @ -3 dBFS output level, unweighted

**SNR @ -40dBFS input:**

> 110dB unweighted

**Linearity:**

t.b.d.

**Crosstalk:**

< -120dB, 0..20kHz

**CMRR:**

> 90dB @ 1kHz

> 80dB @ 20kHz

> 60dB @ 20Hz

**Interchannel phase tracking:**

Better than +- 0.3°, 20Hz to 20kHz

All measurements taken at the least sensitive setting of the input attenuators, i.e. +26dBu sensitivity for line and +6dBu sensitivity for mic inputs. (= sensitivity for 0dBFS output level).

## Parameter Tables

### Analogue Gain Line Input [dB]:

-26.0, -25.0, -24.0, -23.0, etc. in 1dB steps to +16.0

(example: with a gain setting of -26.0, a +26dBu input signal generates a 0dBFS output)

### Analogue Gain Mic Input [dB]:

-6.0, -5.0, -4.0, etc. in 1 dB steps to +54.0

(example: with a gain setting of -6.0, a +6dBu input signal generates a 0dBFS output)

### Digital Output Gain [dB]:

-100.0, -92.0, -89.0, -86.0, -83.0, -80.0, -77.0, -74.0, -71.0, -68.0, -65.0, -62.0, -59.0, -56.0, -53.0, -50.0, -48.0, -46.0, -44.0, -42.0, -40.0, -39.0, -38.0, -37.0, -36.0, -35.0, -34.0, -33.0, -32.0, -30.0, -29.5, -29.0, -28.5, -28.0, -27.5, -27.0, -26.5, -26.0, -25.5, -25.0, -24.5, -24.0, -23.5, -23.0, -22.5, -22.0, -21.5, -21.0, -20.5, -20.0, -19.5, -19.0, -18.5, -18.0, -17.5, -17.0, -16.5, -16.0, -15.5, -15.0, -14.5, -14.0, -13.5, -13.0, -12.5, -12.0, -11.5, -11.0, -10.5, -10.0, -9.5, -9.0, -8.5, -8.0, -7.5, -7.0, -6.5, -6.0, -5.8, -5.6, -5.4, -5.2, -5.0, -4.8, -4.6, -4.4, -4.2, -4.0, -3.8, -3.6, -3.4, -3.2, -3.0, -2.8, -2.6, -2.4, -2.2, -2.0, -1.8, -1.6, -1.4, -1.2, -1.0, -0.8, -0.6, -0.4, -0.2, 0.0, 0.2, 0.4, 0.6, 0.8, 1.0, 1.2, 1.4, 1.6, 1.8, 2.0, 2.2, 2.4, 2.6, 2.8, 3.0, 3.2, 3.4, 3.6, 3.8, 4.0, 4.2, 4.4, 4.6, 4.8, 5.0, 5.2, 5.4, 5.6, 5.8, 6.0, 6.2, 6.4, 6.6, 6.8, 7.0, 7.2, 7.4, 7.6, 7.8, 8.0, 8.2, 8.4, 8.6, 8.8, 9.0, 9.2, 9.4, 9.6, 9.8, 10.0, 10.2, 10.4, 10.6, 10.8, 11.0, 11.2, 11.4, 11.6, 11.8, 12.0, 12.2, 12.4, 12.6, 12.8, 13.0, 13.2, 13.4, 13.6, 13.8, 14.0, 14.2, 14.4, 14.6, 14.8, 15.0, 15.2, 15.4, 15.6, 15.8, 16.0, 16.2, 16.4, 16.6, 16.8, 17.0, 17.2, 17.4, 17.6, 17.8, 18.0

### Compressor Threshold [dBFS]:

-25.0, -24.8, -24.6, -24.4, -24.2, -24.0, -23.8, -23.6, -23.4, -23.2, -23.0, -22.8, -22.6, -22.4, -22.2, -22.0, -21.8, -21.6, -21.4, -21.2, -21.0, -20.8, -20.6, -20.4, -20.2, -20.0, -19.8, -19.6, -19.4, -19.2, -19.0, -18.8, -18.6, -18.4, -18.2, -18.0, -17.8, -17.6, -17.4, -17.2, -17.0, -16.8, -16.6, -16.4, -16.2, -16.0, -15.8, -15.6, -15.4, -15.2, -15.0, -14.8, -14.6, -14.4, -14.2, -14.0, -13.8, -13.6, -13.4, -13.2, -13.0, -12.8, -12.6, -12.4, -12.2, -12.0, -11.8, -11.6, -11.4, -11.2, -11.0, -10.8, -10.6, -10.4, -10.2, -10.0, -9.8, -9.6, -9.4, -9.2, -9.0, -8.8, -8.6, -8.4, -8.2, -8.0, -7.8, -7.6, -7.4, -7.2, -7.0, -6.8, -6.6, -6.4, -6.2, -6.0, -5.8, -5.6, -5.4, -5.2, -5.0, -4.8, -4.6, -4.4, -4.2, -4.0, -3.8, -3.6, -3.4, -3.2, -3.0, -2.8, -2.6, -2.4, -2.2, -2.0, -1.8, -1.6, -1.4, -1.2, -1.0, -0.8, -0.6, -0.4, -0.2, 0.0

### Sampling Rate [kHz]:

44.1, 48.0, 88.2, 96.0, 176.4, 192.0

### POW-R Noise Spectrum

Fig. 10 shows the noise spectrum of the three POW-R algorithms at 44.1 and 88.2 kHz.

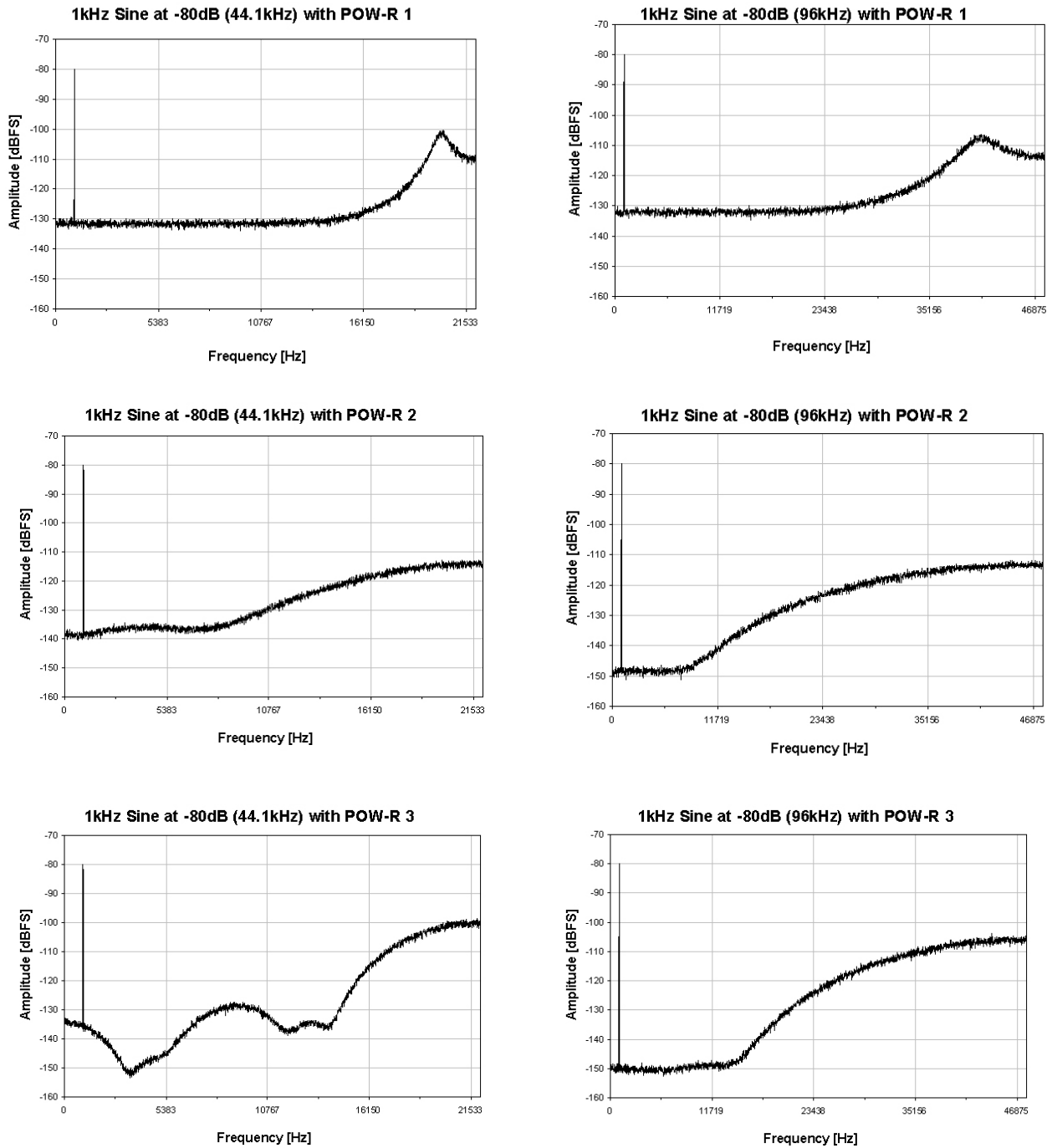

Fig. 10 Output spectrum with 80dBFS / 1kHz sine wave, dithered to 16 Bits, using the three POW-R algorithms at 44.1kHz and 88.2kHz respectively